



 newbits



SERIA URANUS

LUMINĂ SOLARĂ



INTRODUCERE

Specificațiile produsului

01 INTRODUCERE

02 CATALOG

03~
04 AVANTAJE PRINCIPALE

05 SPECIFICAȚII

06 DIAGRAMA OPTICĂ

07 DIMENSIUNI

08 DIMENSIUNI

09 MAI MULTE DETALII

10 TEHNOLOGIE NUCLEU

11~
12 DETALII PACHET

13 UTILIZARE



GARAJ

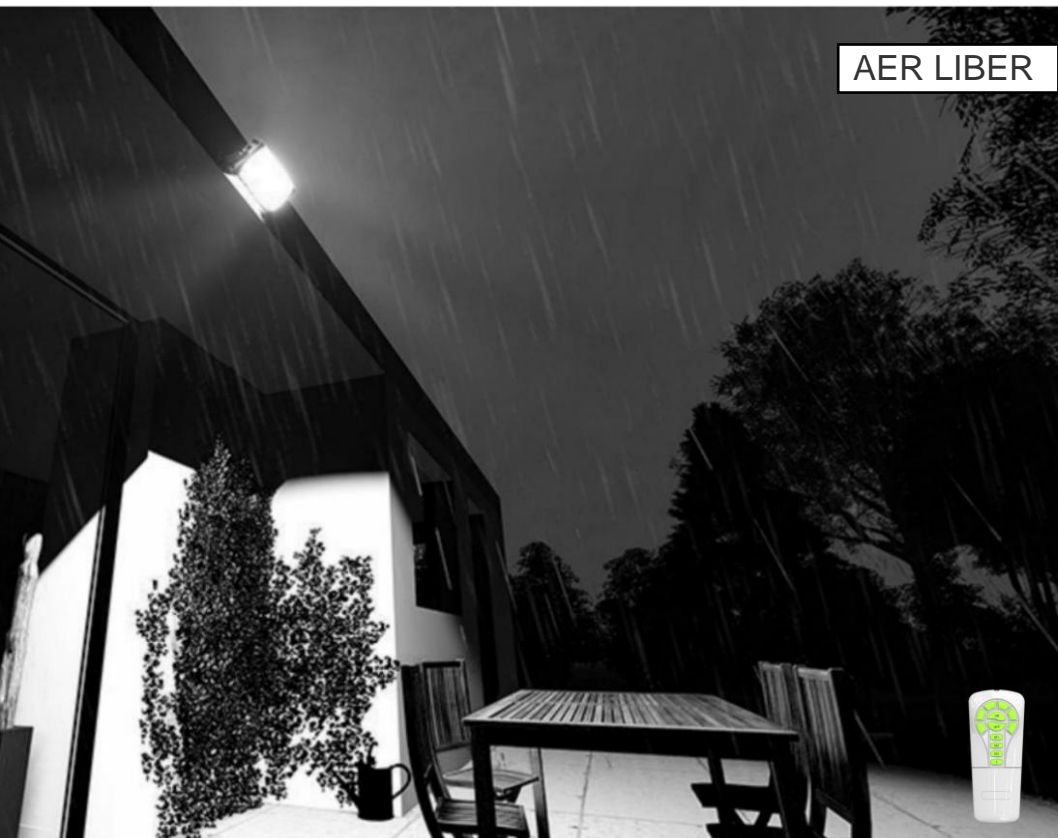

AER LIBER

LAMPA SOLARA



SWL-40PRO

Egal cu lampa cu
incandescenta 600W



SWL-20PRO

Egal cu lampa cu
incandescenta 300W

AVANTAJELE PRODUSULUI

Tehnologia ASL garanteaza 10 nopti de functionare continua
Tehnologia TCS asigura o durata de viata mare a bateriei

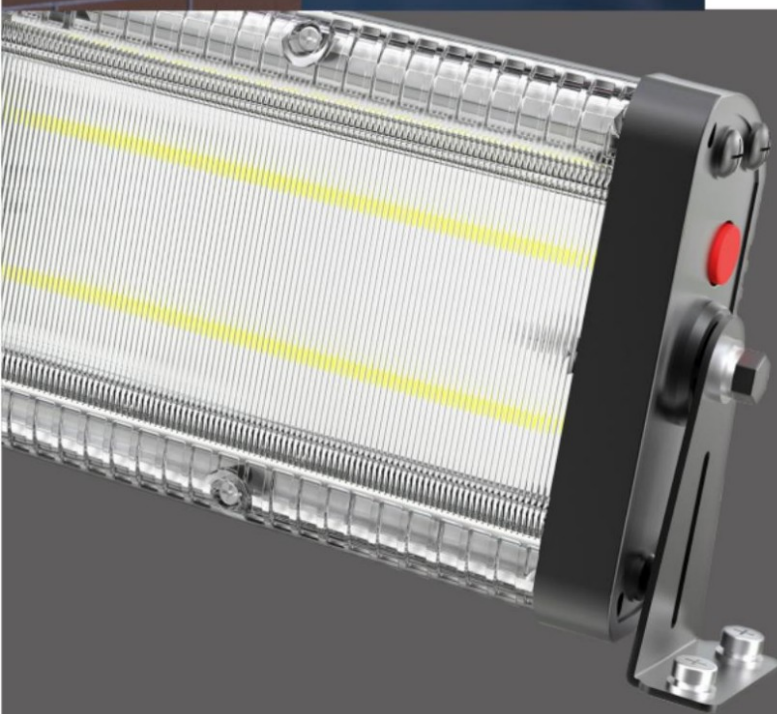
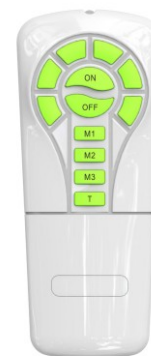

Egal cu lampa cu
incandescenta 300/ 600W

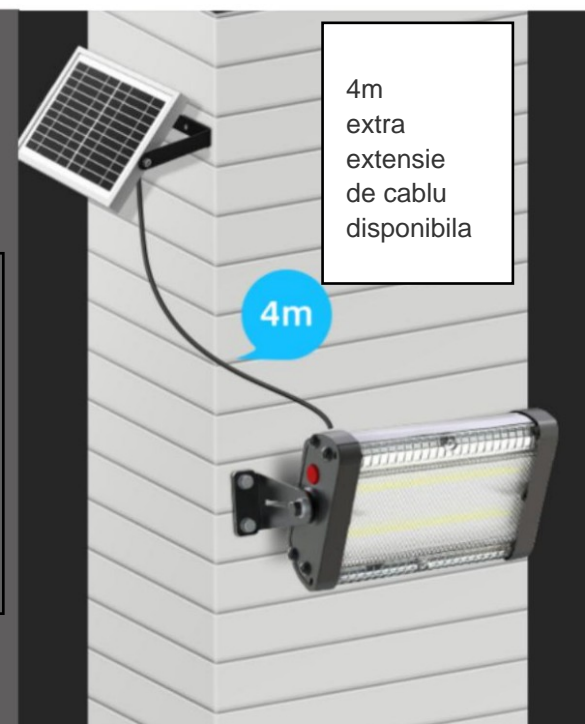

Articol:	SWL-20PRO	SWL-40PRO
Luminozitate	3000 lumeni	6000 lumeni
Panou solar		
Putere	Monocristalin, 14V/5W	Monocristalin, 14V/10W
Baterie Li-ion		
Capacitate	3.7V28.86WH 2.6AH/BUC	3.7V57.72WH 2.6AH/BUC
Temp. de încărcare/descărcare	0~45°C / -20~60°C	0~45°C / -20~60°C
Timp de incarcare	7,5 ore	7,5 ore
LED (OSRAM)	3030 30 buc	3030 60 buc
Temp. culoare	5700KR a 70+	5700KR a 70+
Eficiența	190lm/W	190lm/W
LED UV	-	-
Performanța		
Timp de iluminare în zilele ploioase	>10 zile	>10 zile
Modul de control	Buton comutator, ON/OFF Apăsare lungă 1,5 secunde	
Modul de iluminare (comandă de la distanță)	M1: 50% 1500LM(5H) + 10% 300LM până la zori M2: 30% 900LM(5H) + 10% 300LM până la zori M3: 20% 600LM Până în zori T: 3000LM 2 ore	M1: 50% 3000LM(5H) + 10% 600LM până la zori M2: 30% 1800LM(5H) + 10% 600LM până la zori M3: 20% 1200LM Până în zori T: 6000LM 2 ore
Indicarea modului	M1: Roșu / M2: Verde / M3: Portocaliu T: Lumina verde clipește	
Indicație de capacitate	Verde: >70% Portocaliu: 30%~70% Roșu 10%~30%	Verde: >70% Portocaliu: 30%~70% Roșu: 10%~30%
PIR	-	-
Tehnologia de bază	ALS2.3	ALS2.3
Autocurățare panouri solare	-	-
Clasa IP/IK	IP65	IP65
Înălțime de instalare	-	-

SWL-20PRO / 40 PPRO

Diagrama simulată a drumului

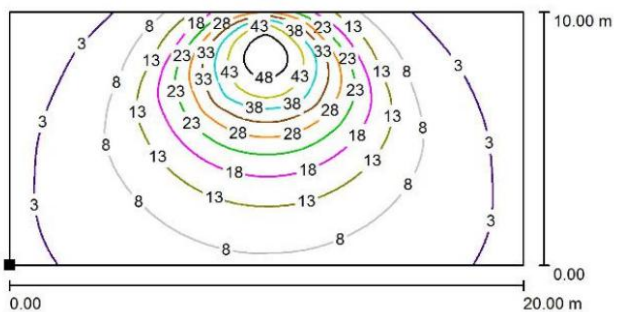

Curba de iluminare

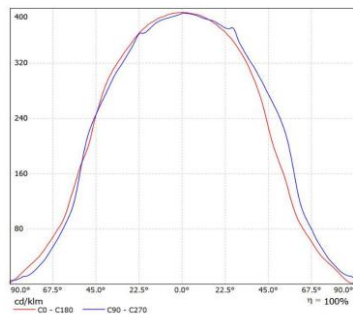

Distribuția Luminanței

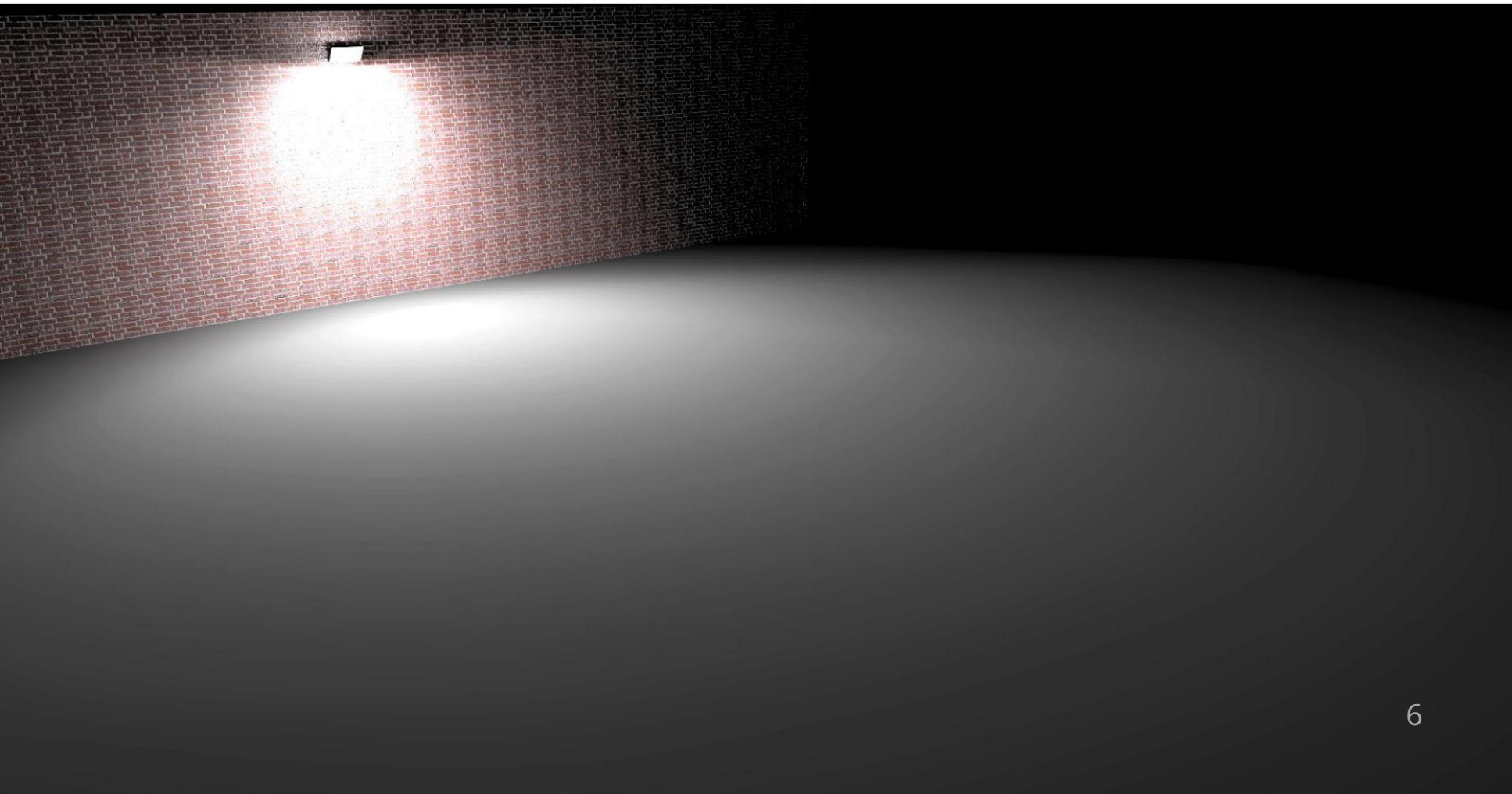
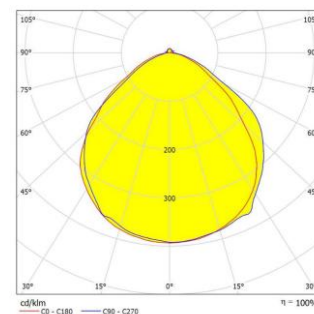

SWL-20PRO

LAMPA SOLARA

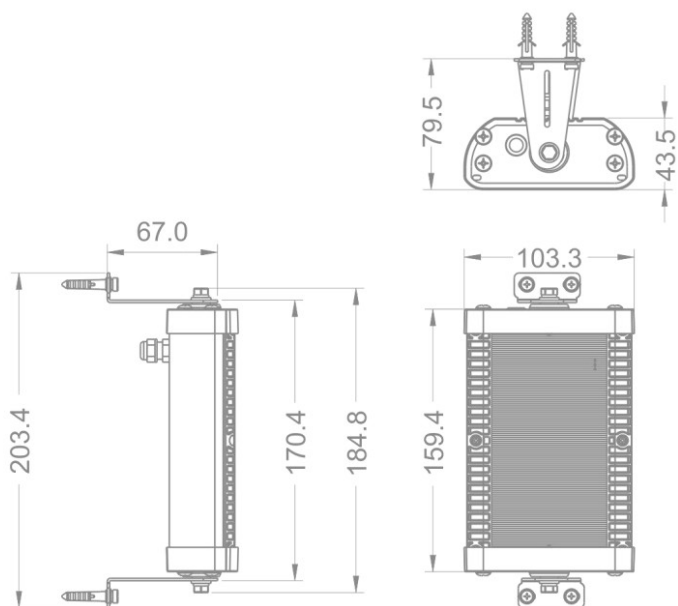

PANOUL SOLAR

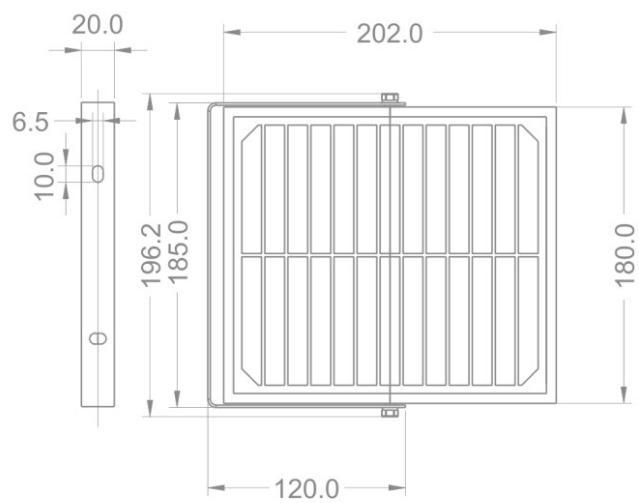

SWL-40PRO

LAMPA SOLARA

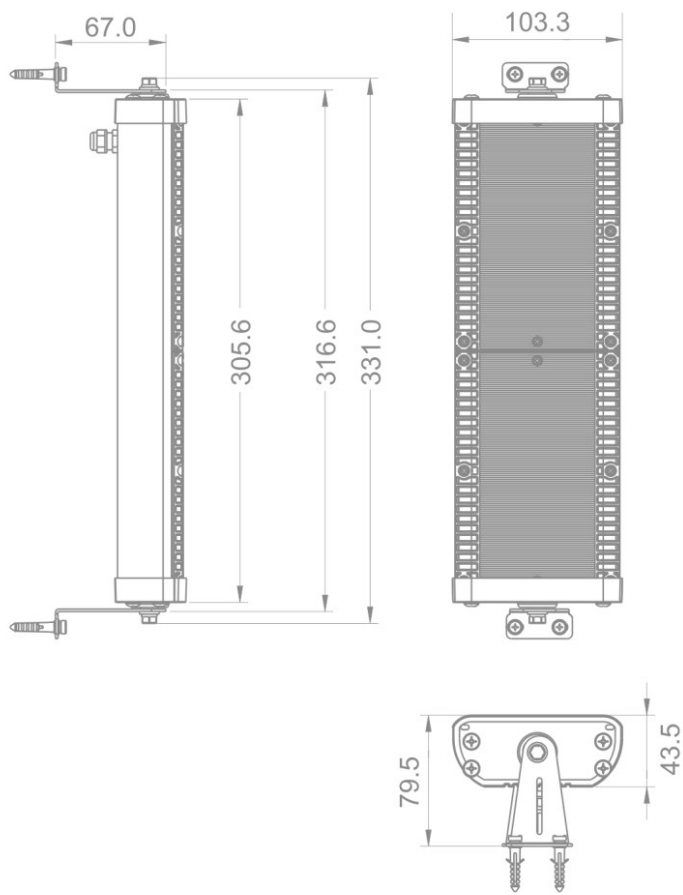

PANOUL SOLAR

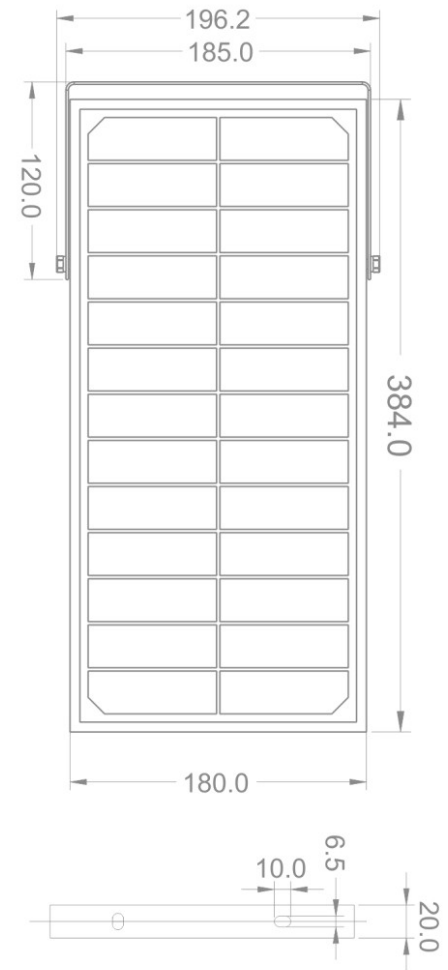

BENEFICII

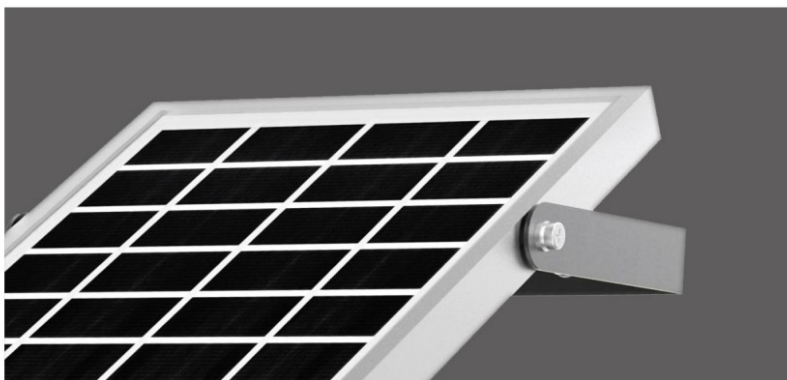

Monocristalina
Eficienta de încărcare solara:> 21%



LED-uri cu lumen mare 190lm/W



Suport pentru comutator

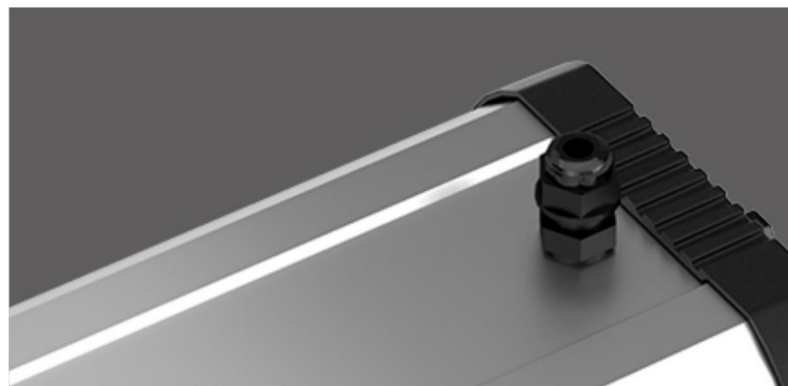

Detalii spate



O companie mare ar trebui sa acorde intotdeauna o atentie ridicata la designul fiecarui detaliu, iar spiritul de maiestrie, ar trebui completat in procesul de proiectare si productie in masa.

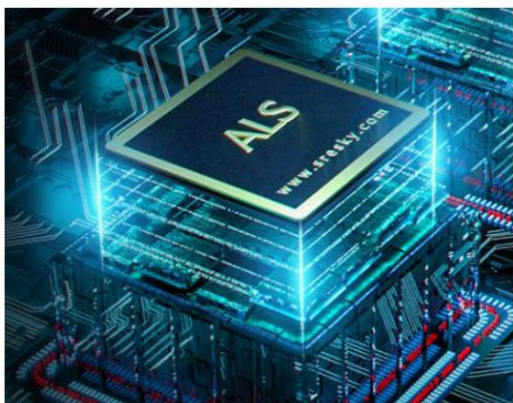

AVANTAJUL ALS

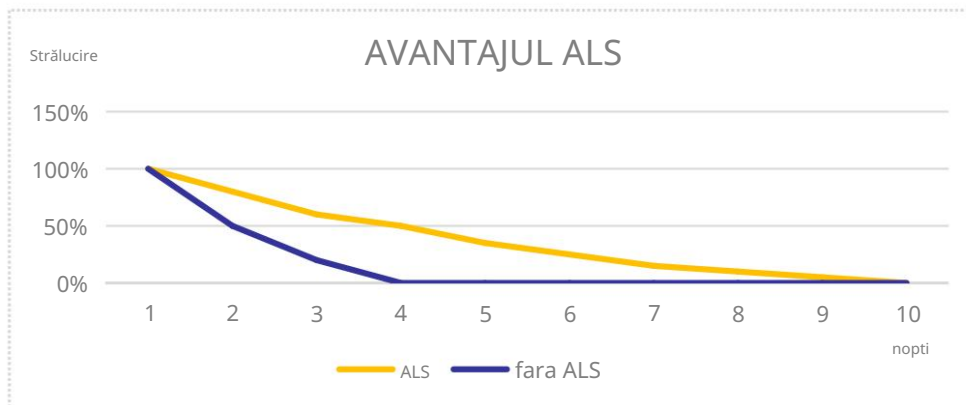

AVANTAJUL TCS

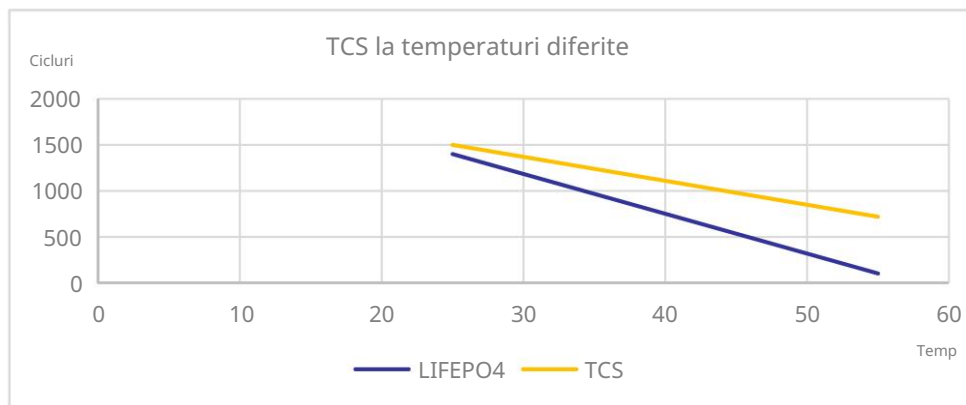

SOLAR LIGHT I DETALII PACHET

LISTA DE PRODUSE

Lumină solară: 1 buc
Panou solar: 1 buc

Suport pentru corpul lămpii: 1 buc
Suport panou solar: 1 buc
Șurub: 4 SET

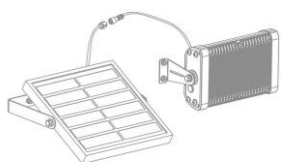

CUTIE INTERIOARĂ
DIMENSIUNE: 190*85*210mm
1 buc / SET



1 STRATURI
1 STRAT = 8 BUC

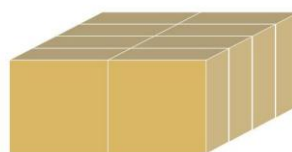

MASTER CARTON
DIMENSIUNE: 400*360*230mm
8 BUC. / CTN

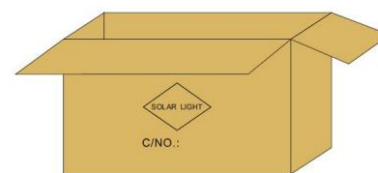

CUTIE DE CARTON

NUMĂRUL STRATULUI

CUTIE DE CULORI

LISTA DE PRODUSE

PASUL 1

PASUL 2

PASUL 3

PASUL 4

NUMARUL MODELULUI	AMBALARE METODĂ	PCS/CTN	CANTITATE (BUC)	CTN CANTITATE	DIMENSIUNE CARTON (MM)	NW (KG)	GW (KG)
SWL- 20PRO	CUTIE INTERIOARĂ	1	1	1	190*85*210	1.2	1.4
	CUTIE DE CARTON	8	8	1	400*360*230	9.6	11.2

Greutatea netă și greutatea brută
sunt doar pentru referință

LISTA DE PRODUSE

Lumină solară: 1 buc
 Panou solar: 1 buc
 Suport pentru corpul lămpii: 1 buc
 Suport panou solar: 1 buc
 Șurub: 4 SET

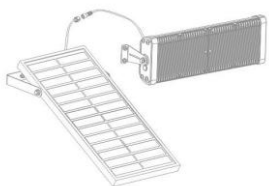

CUTIE INTERIOARĂ
 DIMENSIUNE: 390*85*190mm
 1 buc / SET



1 STRAT
 1 STRAT = 6 BUC

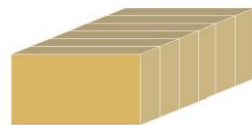

MASTER CARTON
 DIMENSIUNE: 530*410*210mm
 4 BUC. / CTN

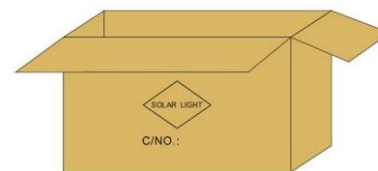

NUMĂRUL STRATULUI

CUTIE DE CARTON

CUTIE COLOR

LISTA DE PRODUSE

PASUL 1

PASUL 2

PASUL 3

PASUL 4

NUMARUL MODELULUI	AMBALARE METODĂ	PCS/CTN	CANTITATE (BUC)	CTN CANTITATE	DIMENSIUNE CARTON (MM)	NV (KG)	GW (KG)
SWL- 40PRO	CUTIE INTERIOARĂ	1	1	1	390*85*190	2.2	2.6
	CUTIE DE CARTON	6	6	1	530*410*210	13.2	15.6

Greutatea netă și greutatea brută
 sunt doar pentru referință

S / O / L / A / R / L / I / G / H / T

VA MULTUMIM !

CONTACT: Email: info@newbits.ro